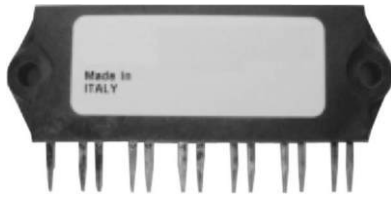

## IGBT SIP Module (Fast IGBT)

**IMS-2**

### FEATURES

- Fully isolated printed circuit board mount package
- Switching-loss rating includes all “tail” losses
- HEXFRED® soft ultrafast diodes
- Optimized for medium speed 1 to 10 kHz  
See fig. 1 for current vs. frequency curve
- Totally lead (Pb)-free
- Designed and qualified for industrial level

**RoHS  
COMPLIANT**

### PRODUCT SUMMARY

#### OUTPUT CURRENT IN A TYPICAL 5.0 kHz MOTOR DRIVE

$I_{RMS}$ per phase (3.1 kW total) with $T_C = 90\text{ }^\circ\text{C}$	11 A
$T_J$	125 $^\circ\text{C}$
Supply voltage (DC)	360 V
Power factor	0.8
Modulation depth See fig. 1	115 %
$V_{CE(on)}$ (typical) at $I_C = 4.8\text{ A}$ , 25 $^\circ\text{C}$	1.41 V

### DESCRIPTION

The IGBT technology is the key to the advanced line of IMS (Insulated Metal Substrate) power modules. These modules are more efficient than comparable bipolar transistor modules, while at the same time having the simpler gate-drive requirements of the familiar power MOSFET. This superior technology has now been coupled to a state of the art materials system that maximizes power throughput with low thermal resistance. This package is highly suited to motor drive applications and where space is at a premium.

### ABSOLUTE MAXIMUM RATINGS

PARAMETER	SYMBOL	TEST CONDITIONS	MAX.	UNITS
Collector to emitter voltage	$V_{CES}$		600	V
Continuous collector current, each IGBT	$I_C$	$T_C = 25\text{ }^\circ\text{C}$	8.8	A
		$T_C = 100\text{ }^\circ\text{C}$	4.8	
Pulsed collector current	$I_{CM}$	Repetitive rating; $V_{GE} = 20\text{ V}$ , pulse width limited by maximum junction temperature. See fig. 20	26	
Clamped inductive load current	$I_{LM}$	$V_{CC} = 80\%$ ( $V_{CES}$ ), $V_{GE} = 20\text{ V}$ , $L = 10\text{ }\mu\text{H}$ , $R_G = 50\text{ }\Omega$ See fig. 19	800	
Diode continuous forward current	$I_F$	$T_C = 100\text{ }^\circ\text{C}$	3.4	
Diode maximum forward current	$I_{FM}$		26	
Gate to emitter voltage	$V_{GE}$		$\pm 20$	
Isolation voltage	$V_{ISOL}$	Any terminal to case, $t = 1\text{ min}$	2500	$V_{RMS}$
Maximum power dissipation, each IGBT	$P_D$	$T_C = 25\text{ }^\circ\text{C}$	23	W
		$T_C = 100\text{ }^\circ\text{C}$	9.1	
Operating junction and storage temperature range	$T_J, T_{Stg}$		- 40 to + 150	$^\circ\text{C}$
Soldering temperature		For 10 s	300 (0.063" (1.6 mm) from case)	
Mounting torque		6-32 or M3 screw	5 to 7 (0.55 to 0.8)	lbf · in (N · m)

### THERMAL AND MECHANICAL SPECIFICATIONS

PARAMETER	SYMBOL	TYP.	MAX.	UNITS
Junction to case, each IGBT, one IGBT in conduction	$R_{thJC}$ (IGBT)	-	5.5	$^\circ\text{C/W}$
Junction to case, each diode, one diode in conduction	$R_{thJC}$ (diode)	-	9.0	
Case to sink, flat, greased surface	$R_{thCS}$ (module)	0.1	-	
Weight of module		20 (0.7)	-	g (oz.)

<b>ELECTRICAL SPECIFICATIONS</b> ( $T_J = 25\text{ }^\circ\text{C}$ unless otherwise specified)						
PARAMETER	SYMBOL	TEST CONDITIONS	MIN.	TYP.	MAX.	UNITS
Collector to emitter breakdown voltage	$V_{(BR)CES}$	$V_{GE} = 0\text{ V}$ , $I_C = 250\text{ }\mu\text{A}$ Pulse width $\leq 80\text{ }\mu\text{s}$ , duty factor $\leq 0.1\%$	600	-	-	V
Temperature coeff. of breakdown voltage	$\Delta V_{(BR)CES} / \Delta T_J$	$V_{GE} = 0\text{ V}$ , $I_C = 1.0\text{ mA}$	-	0.72	-	V/ $^\circ\text{C}$
Collector to emitter saturation voltage	$V_{CE(on)}$	$I_C = 4.8\text{ A}$	-	1.41	1.7	V
		$I_C = 8.8\text{ A}$	-	1.66	-	
		$I_C = 4.8\text{ A}$ , $T_J = 150\text{ }^\circ\text{C}$	-	1.42	-	
Gate threshold voltage	$V_{GE(th)}$	$V_{CE} = V_{GE}$ , $I_C = 250\text{ }\mu\text{A}$	3.0	-	6.0	
Gate to emitter leakage current	$I_{GES}$	$V_{GE} = \pm 20\text{ V}$	-	-	$\pm 100$	nA
Temperature coeff. of threshold voltage	$\Delta V_{GE(th)} / \Delta T_J$	$V_{GE} = 0\text{ V}$ , $I_C = 1.0\text{ mA}$	-	-11	-	mV/ $^\circ\text{C}$
Forward transconductance	$g_{fe}$	$V_{CE} = 100\text{ V}$ , $I_C = 4.8\text{ A}$ Pulse width $5.0\text{ }\mu\text{s}$ ; single shot	2.9	5.0	-	S
Zero gate voltage collector current	$I_{CES}$	$V_{GE} = 0\text{ V}$ , $V_{CE} = 600\text{ V}$	-	-	250	$\mu\text{A}$
		$V_{GE} = 0\text{ V}$ , $V_{CE} = 600\text{ V}$ , $T_J = 150\text{ }^\circ\text{C}$	-	-	1700	
Diode forward voltage drop	$V_{FM}$	$I_C = 8.0\text{ A}$	-	1.4	1.7	V
		$I_C = 8.0\text{ A}$ , $T_J = 150\text{ }^\circ\text{C}$	-	1.3	1.6	

<b>SWITCHING CHARACTERISTICS</b> ( $T_J = 25\text{ }^\circ\text{C}$ unless otherwise specified)							
PARAMETER	SYMBOL	TEST CONDITIONS	MIN.	TYP.	MAX.	UNITS	
Total gate charge (turn on)	$Q_g$	$I_C = 4.8\text{ A}$	-	30	45	nC	
Gate to emitter charge (turn on)	$Q_{ge}$	$V_{CC} = 400\text{ V}$	-	4.0	6.0		
Gate to collector charge	$Q_{gc}$	See fig. 8	-	13	20		
Turn-on delay time	$t_{d(on)}$	$T_J = 25\text{ }^\circ\text{C}$ $I_C = 4.8\text{ A}$ , $V_{CC} = 480\text{ V}$ $V_{GE} = 15\text{ V}$ , $R_G = 50\text{ }\Omega$ Energy losses include "tail" and diode reverse recovery.	-	49	-	ns	
Rise time	$t_r$		-	22	-		
Turn-off delay time	$t_{d(off)}$		-	200	300		
Fall time	$t_f$		-	214	320		
Turn-on switching loss	$E_{on}$		-	0.23	-		mJ
Turn-off switching loss	$E_{off}$	See fig. 9, 10, 18	-	0.33	-		
Total switching loss	$E_{ts}$	-	0.45	0.70			
Turn-on delay time	$t_{d(on)}$	$T_J = 150\text{ }^\circ\text{C}$ , $I_C = 4.8\text{ A}$ , $V_{CC} = 480\text{ V}$ $V_{GE} = 15\text{ V}$ , $R_G = 50\text{ }\Omega$ Energy losses include "tail" and diode reverse recovery	-	48	-	ns	
Rise time	$t_r$		-	25	-		
Turn-off delay time	$t_{d(off)}$		-	435	-		
Fall time	$t_f$		-	364	-		
Total switching loss	$E_{ts}$		See fig. 10, 11, 18	-	0.93		-
Input capacitance	$C_{ies}$	$V_{GE} = 0\text{ V}$ $V_{CC} = 30\text{ V}$	See fig. 7	-	340	-	pF
Output capacitance	$C_{oes}$			-	63	-	
Reverse transfer capacitance	$C_{res}$			-	5.9	-	
Diode reverse recovery time	$t_{rr}$	$T_J = 25\text{ }^\circ\text{C}$	See fig. 14	-	37	55	ns
		$T_J = 125\text{ }^\circ\text{C}$			-	55	
Diode peak reverse recovery current	$I_{rr}$	$T_J = 25\text{ }^\circ\text{C}$	See fig. 15	-	3.5	50	A
		$T_J = 125\text{ }^\circ\text{C}$			-	4.5	
Diode reverse recovery charge	$Q_{rr}$	$T_J = 25\text{ }^\circ\text{C}$	See fig. 16	-	65	138	nC
		$T_J = 125\text{ }^\circ\text{C}$			-	124	
Diode peak rate of fall of recovery during $t_b$	$dl_{(rec)M} / dt$	$T_J = 25\text{ }^\circ\text{C}$	See fig. 17	-	240	-	A/ $\mu\text{s}$
		$T_J = 125\text{ }^\circ\text{C}$			-	210	

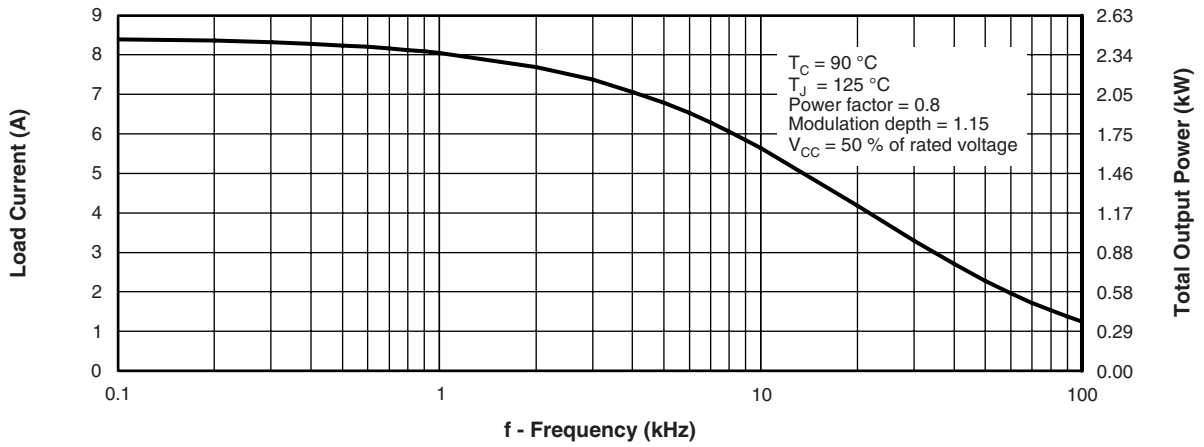

Fig. 1 - Typical Load Current vs. Frequency  
(Load Current =  $I_{RMS}$  of Fundamental)

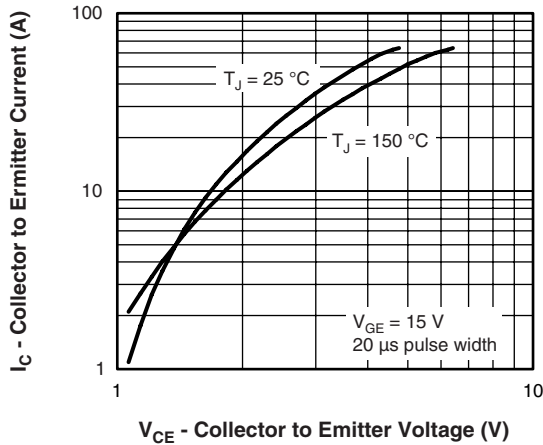

Fig. 2 - Typical Output Characteristics

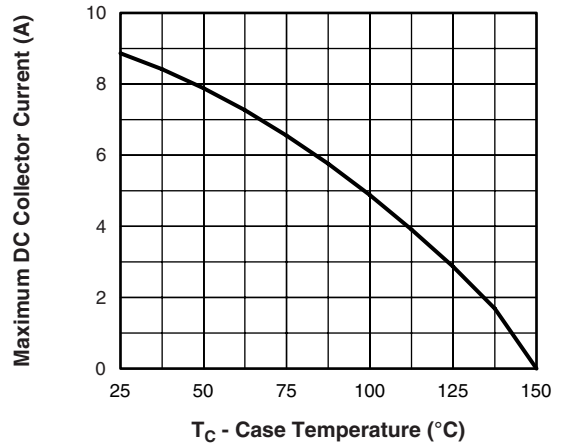

Fig. 4 - Maximum Collector Current vs. Case Temperature

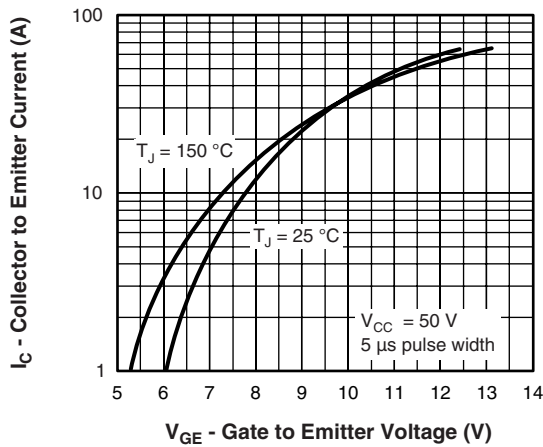

Fig. 3 - Typical Transfer Characteristics

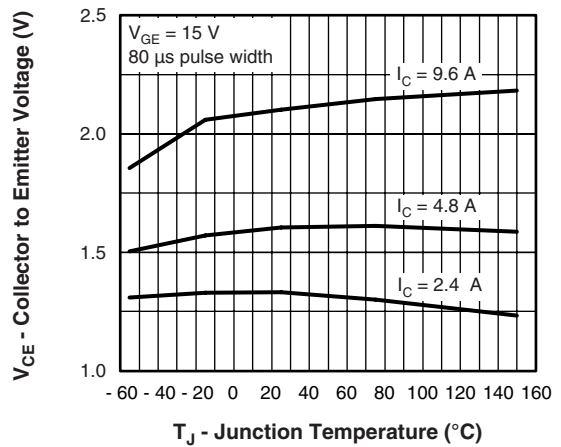

Fig. 5 - Typical Collector to Emitter Voltage vs. Junction Temperature

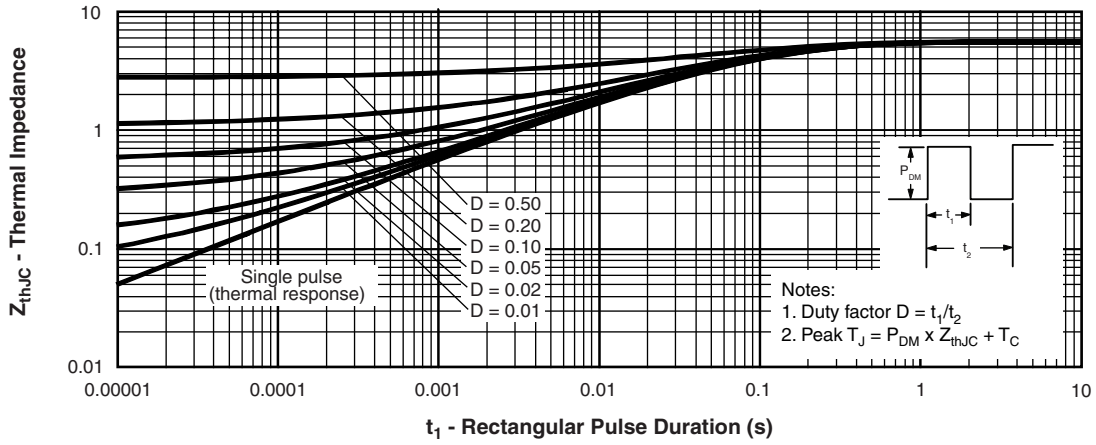

Fig. 6 - Maximum Effective Transient Thermal Impedance, Junction to Case

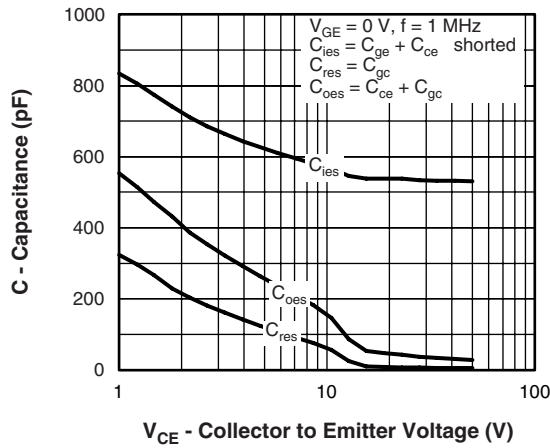

Fig. 7 - Typical Capacitance vs. Collector to Emitter Voltage

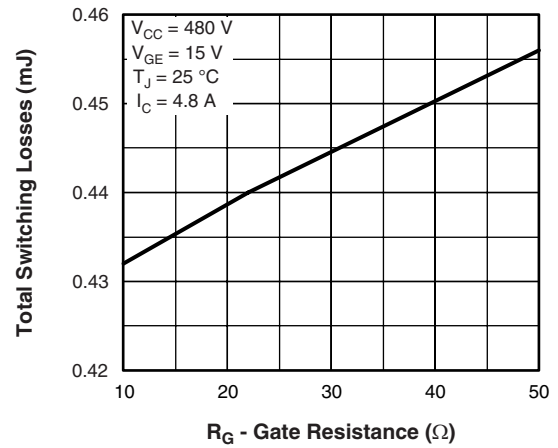

Fig. 9 - Typical Switching Losses vs. Gate Resistance

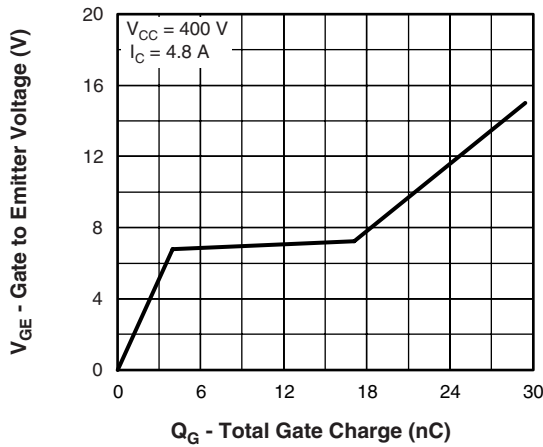

Fig. 8 - Typical Gate Charge vs. Gate to Emitter Voltage

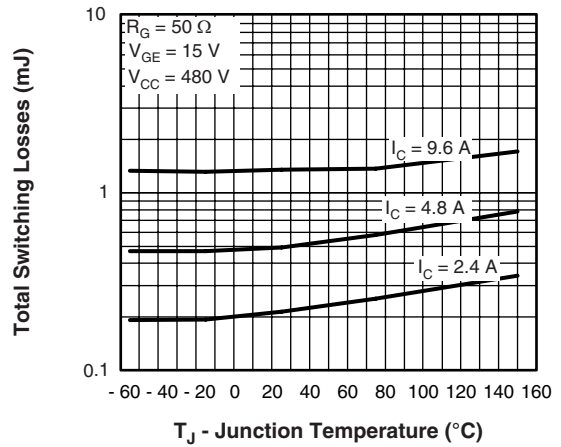

Fig. 10 - Typical Switching Losses vs. Junction Temperature

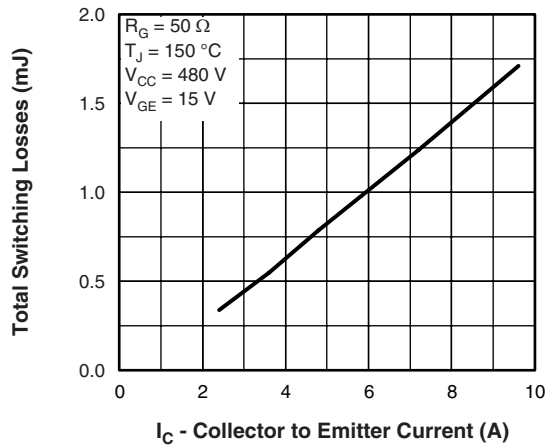

Fig. 11 - Typical Switching Losses vs. Collector to Emitter Current

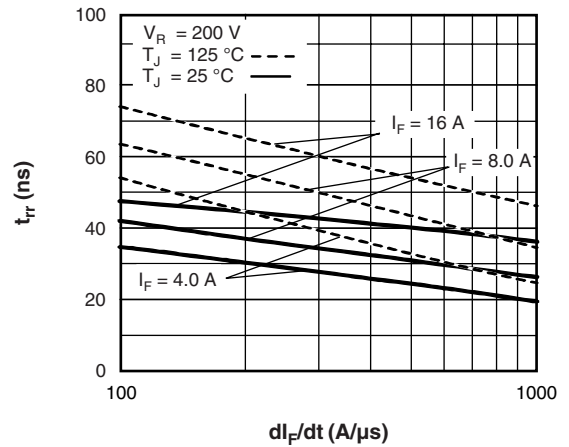

Fig. 14 - Typical Reverse Recovery Time vs.  $di_F/dt$

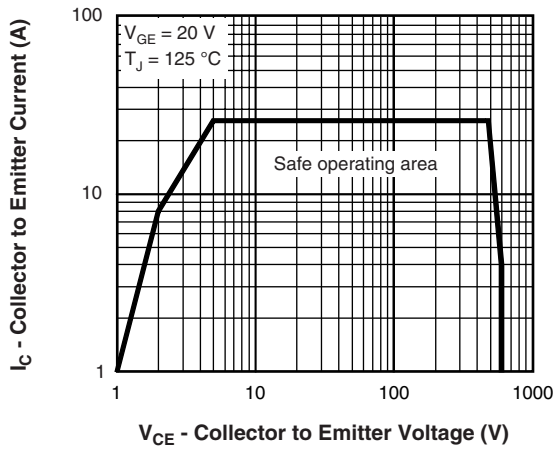

Fig. 12 - Turn-Off SOA

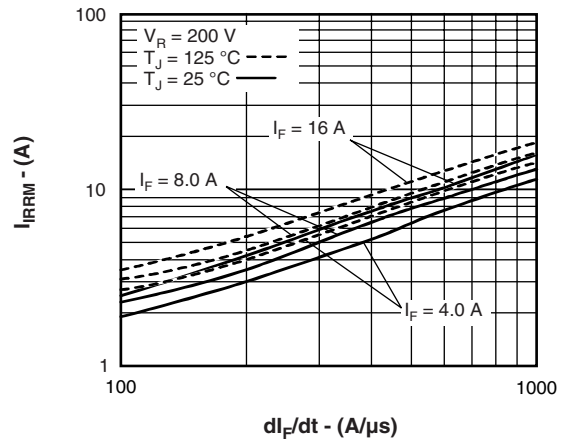

Fig. 15 - Typical Recovery Current vs.  $di_F/dt$

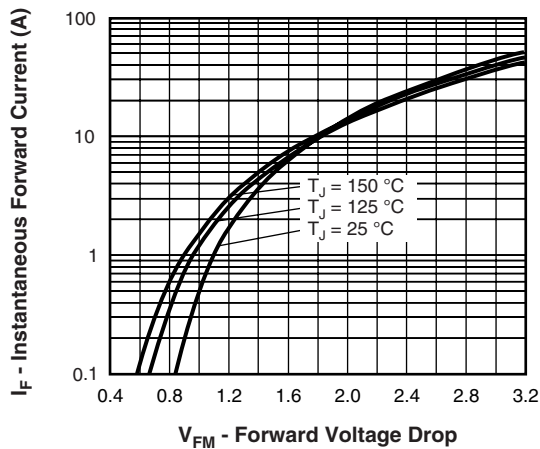

Fig. 13 - Maximum Forward Voltage Drop vs. Instantaneous Forward Current

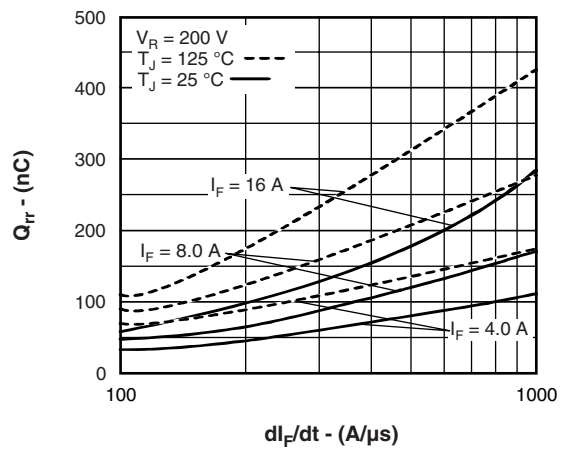

Fig. 16 - Typical Stored Charge vs.  $di_F/dt$

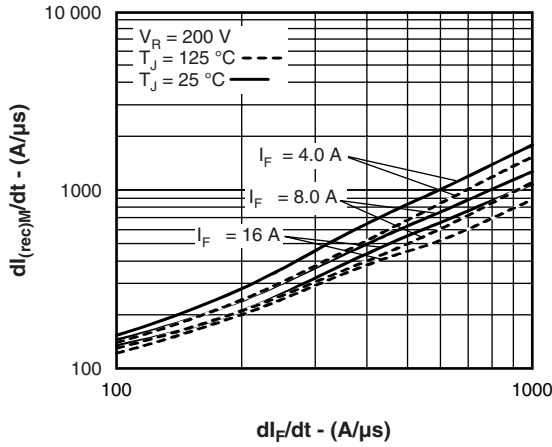

Fig. 17 - Typical  $dI_{(REC)M}/dt$  vs  $dI_F/dt$

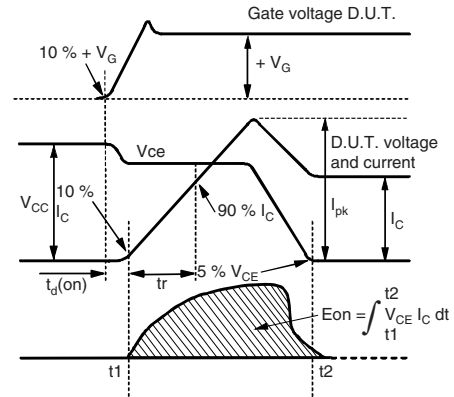

Fig. 18c - Test Waveforms of Circuit of Fig. 18a, Defining  $E_{on}$ ,  $t_{d(on)}$ ,  $t_r$

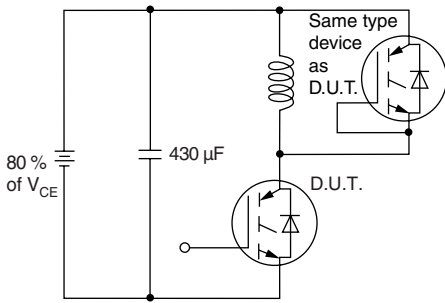

Fig. 18a - Test Circuit for Measurement of  $I_{LM}$ ,  $E_{on}$ ,  $E_{off}(\text{diode})$ ,  $t_{rr}$ ,  $Q_{rr}$ ,  $I_{rr}$ ,  $t_{d(on)}$ ,  $t_r$ ,  $t_{d(off)}$ ,  $t_f$

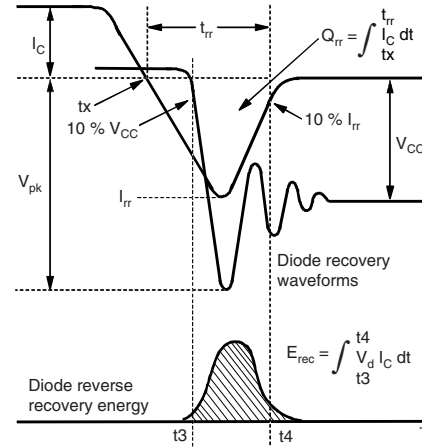

Fig. 18d - Test Waveforms of Circuit of Fig. 18a, Defining  $E_{rec}$ ,  $t_{rr}$ ,  $Q_{rr}$ ,  $I_{rr}$

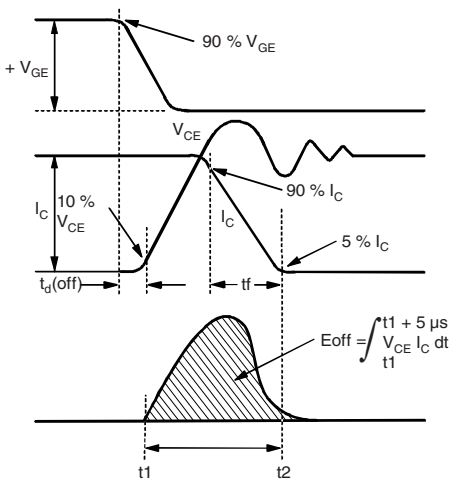

Fig. 18b - Test Waveforms of Circuit of Fig. 18a, Defining  $E_{off}$ ,  $t_{d(off)}$ ,  $t_f$

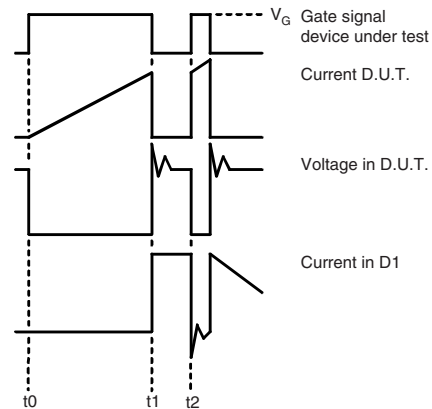

Fig. 18e - Macro Waveforms for Figure 18a's Test Circuit

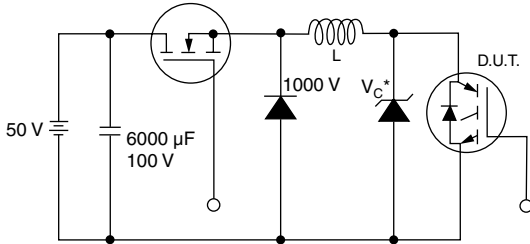

Fig. 19 - Clamped Inductive Load Test Circuit

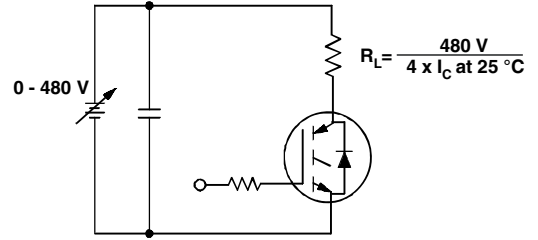
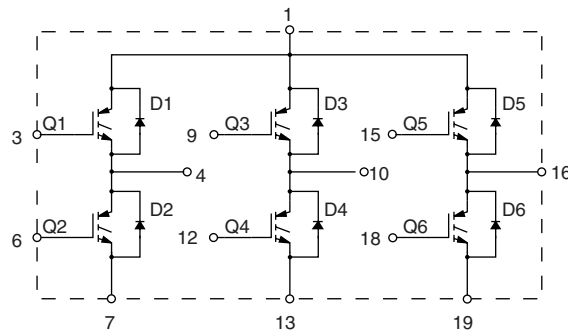

Fig. 20 - Pulsed Collector Current Test Circuit

**CIRCUIT CONFIGURATION**



LINKS TO RELATED DOCUMENTS	
Dimensions	<a href="http://www.vishay.com/doc?95066">http://www.vishay.com/doc?95066</a>



## Disclaimer

All product specifications and data are subject to change without notice.

Vishay Intertechnology, Inc., its affiliates, agents, and employees, and all persons acting on its or their behalf (collectively, "Vishay"), disclaim any and all liability for any errors, inaccuracies or incompleteness contained herein or in any other disclosure relating to any product.

Vishay disclaims any and all liability arising out of the use or application of any product described herein or of any information provided herein to the maximum extent permitted by law. The product specifications do not expand or otherwise modify Vishay's terms and conditions of purchase, including but not limited to the warranty expressed therein, which apply to these products.

No license, express or implied, by estoppel or otherwise, to any intellectual property rights is granted by this document or by any conduct of Vishay.

The products shown herein are not designed for use in medical, life-saving, or life-sustaining applications unless otherwise expressly indicated. Customers using or selling Vishay products not expressly indicated for use in such applications do so entirely at their own risk and agree to fully indemnify Vishay for any damages arising or resulting from such use or sale. Please contact authorized Vishay personnel to obtain written terms and conditions regarding products designed for such applications.

Product names and markings noted herein may be trademarks of their respective owners.